

A Correlation Analysis and Visualization of Climate Change using Post-Disaster Heterogeneous Datasets

Sukeerthi Mandyam*¹, Shanmuga Priya M.G²., Shalini S³., Kavitha S⁴

^{1, 2, 3, 4} Dept of Computer Science and Engineering,

^{1, 2, 3, 4} Sri Sivasubramaniya Nadar College of Engineering, Chennai, Tamil Nadu, India

*Corresponding author:

E-mail: sukeerthi18175@cse.ssn.edu.in

ACCEPTED MANUSCRIPT

GRAPHICAL ABSTRACT

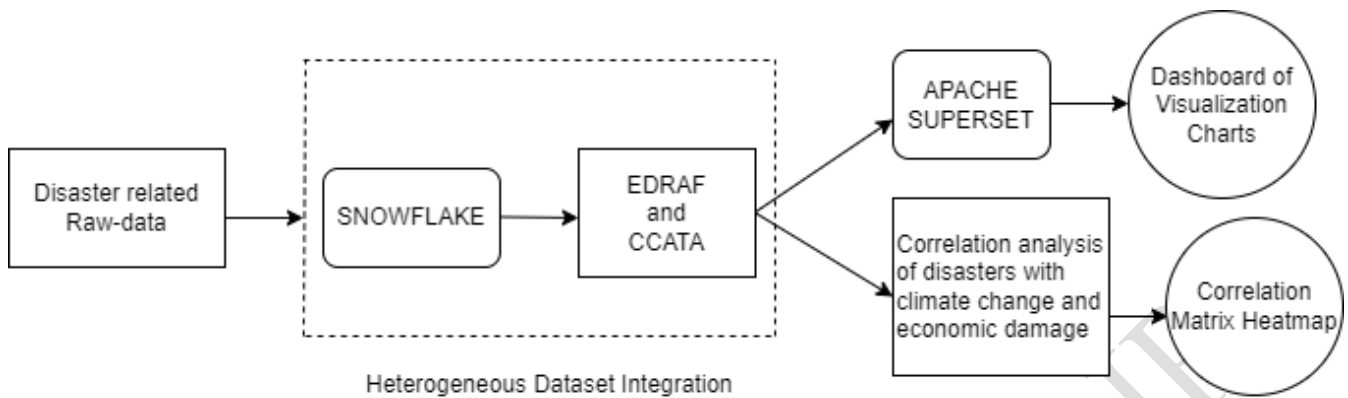

ABSTRACT

There are numerous geo-climatic and human factors that contribute to the occurrence of natural disasters in the real-world scenario. Besides the study of causes and preconditions of such calamities, post-disaster analysis is essential for the efficient management of the disaster situation. This process needs timely and accurate data in light of the increasing frequency and severity of climate change-related extreme weather events. The analysis of disaster data involves the challenging task of integrating multiple heterogeneous sources, data ingestion and visualization. This paper aims at providing a three-dimensional analytical view of disaster data as time-series charts and a statistical model to evaluate the correlation between the occurrence of disasters, climate change and the corresponding economic damages (as a percentage of GDP). The created corpus consists of two unified heterogeneous datasets. The first one forms the basis for exploratory data analysis involving visualization charts for disaster-related factors. The second dataset involves temperature anomaly information which allows for climate change analysis. The integration of the above datasets provides scope for correlation analysis using three different variations of coefficients. Therefore, statistical methodologies are leveraged to play important role in managing disasters, from preparation to recovery and reporting. The graphical representations provide insights on regional trends that follow, related to factors such as the proportion of each type of disaster in the various losses incurred. Therefore, obtaining reliable information about the population, the economy and climate are crucial both for risk management and preparedness and for responding to disasters. The research puts forth a detailed statistical methodology with a spatial dimension to study the impacts on the economy and infrastructure in the aftermath of a disaster thereby ensuring specialized assistance. The inference of the analysis confirmed a positive correlation between climate change and occurrence of natural disasters. Therefore, statistical evidence of an important phenomenon like climate change affecting natural disasters brings awareness among the population in the society to be more environmentally responsible.

Keywords: Disasters, time-series charts, correlation analysis, climate change, economic damage, disaster recovery.

1. Introduction

Natural disasters have long been an area of great interest in the research community since they repeatedly cause damage and economic loss in various fields. The current scope of research cannot predict the occurrence and severe impacts of a disaster with acceptable accuracy. The issue of limited resources emerges because this unpredictability makes it difficult to allocate adequate resources in advance. Although the effects of natural disasters on humans are extensive, economic development is hindered to a large extent years after their occurrence.

Environmentalists suggested that these erratic patterns are probably due to climate change and it is high time we transit quickly to a preparedness-centric approach rather than continuing to be in the relief-centric mode. The motivation of the proposed research is to present insights on various disaster related factors in the real-time scenario through interactive charts and further analyzing patterns between these factors to draw useful conclusions based on their correlation. The inferences of relevant patterns between climate change and disaster occurrence and corresponding economic damages helps the population and the government to become more aware of the causes of the disasters that can be controlled through proper action. The analysis also provides appropriate metrics for efficient planning post the disaster occurrence to ensure faster relief and emergency response through the allocation of required resources. The resulting conclusion embodies the correlation between the most important yet uncertain aspects of geographical existence in a generic sense, which can create awareness since a mathematical and conceptual proof is provided.

The research attempts to bridge multiple gaps in the domain of climate change and natural disaster analysis by making essential contributions in terms of correlating the environmental impacts to real-world problems. First, a data corpus has been created by collecting information required for analysis from multiple heterogeneous data sources and integrating them using data warehousing tools and techniques. Second, by utilizing the data corpus created, the study extends the limited perspective of disaster factors and presents the statistical analysis in an easily interpretable manner. Third, the correlation aspect of general attributes like temperature anomaly, disaster frequency and economic

loss has been formulated by adopting statistical measures that are well researched. For specific regions and factors in interest, a quantitative analysis was carried out and the inferences have been discussed.

The creation of disaster data corpus from heterogeneous datasets unifies disparate databases and provides a uniform conceptual schema to build a common interface. By integrating closely-related datasets using common attributes, a consolidated analysis is possible by incorporating multiple factors. For exploratory data analysis of these disaster factors, the main dataset was outsourced from EM-DAT (Emergency Events Database), which is a global database on natural and technological disasters, containing essential core data on the occurrence and effects of more than 21,000 disasters in the world, from 1900 to the present [1]. By extracting the useful metrics for analysis from raw datasets and combining them with data from open-source platforms like Kaggle offering the earth's temperature over time, an integrated corpus was created to meet the requirements for the analysis methodology [2].

A considerable number of inferences can be fetched from the dataset by defining certain metrics as attributes for the analysis. For instance, time-series charts for visualizing the disaster scenario can provide a whole new dimensional view of the data. To gain an insightful perspective about the raw data, it needs to be combined with relatable effects such as economic losses. Statistical formulas can be used to focus on an alarming aspect related to disasters such as climate change and find out the actual consequential impact of global warming. Therefore, a correlation analysis is formulated between the average temperature of the earth and the frequency of natural disasters and the corresponding economic indicators of a region. The novelty of the proposed research lies in the identification and collection of data from various sources that potentially lead to useful insights when integrated using common attributes. The underlying software, Snowflake is used for storing and integrating metadata, which is a unique data warehousing technique on its own. The cloud integration of the structured datasets with data visualization tools such as Apache Superset enables cross platform collaboration without any underlying architecture which facilitates convenient data analysis.

Furthermore, the datasets are used for applying correlation analysis between the related disaster factors to mathematically extract dependencies.

The remaining sections of the paper are structured as follows: Section 2 discusses the literature survey involved in disaster management, followed by Section 3 which describes the methods adopted in analysis. Section 4 is subdivided as experimental setup and performance analysis elucidating the results which are followed by discussion and concluding remarks in Section 5 and Section 6 respectively.

2. Related Works

The research on existing literature initially focuses on identifying the causes of disasters and gathering divergent perceptions specifically about climate change. We observe the trends in disaster damages related to life and economic losses and how effective early warning systems have proven to be in emergency-response situations. Furthermore, we explore empirical assessments that emphasize the way climate change translates to economic damages and the importance of including vulnerability and socio-economic factors for analysis. The data integration methods and the latest open-source technologies needed to build a consistent data corpus and visualizations were studied. Lastly, we examine suitable statistical approaches that could be used for analysis such as the correlation between factors and a comparative model for inferring results across various regions and types of disasters.

2.1 Disasters and climate change

UNECE has made recommendations to help countries harness official statistics to improve disaster response [3]. They have narrowed down two stark trends that are becoming ever-more present in today's world: rapid urbanization, and a growing number and intensity of hazardous events related to climate change. The combination of these two forces results in increased exposure to risk for people, the economy and the environment. A recent study conducted by Gonzalo et al. found that people have different perceptions of climate change and its effects on disaster occurrences that differ regionally and socio-economically [4]. The studies related to disasters are performed to estimate damage sizes by using various medium variables such as previous damage data, and economic

indicators by countries. UNDRR (UN Office for Disaster Risk Reduction) published a report to mark the International Day for Disaster Risk Reduction on October 13, 2020, and this confirms the extent to which extreme weather and climate change have dominated the disaster landscape in recent times [5].

2.2 *Effects of disasters on human life and economy*

The World Meteorological Organization informed that weather-related disasters have increased causing more damage but fewer deaths. The number of disasters has increased by a factor of five over the 50-year period, driven by climate change, more extreme weather and improved reporting [6]. Fortunately, due to improved early warning mechanisms, the number of deaths has significantly gone down. From 1970 to 2020, weather, climate and water hazards accounted for 50% of all disasters, 45% of reported deaths and 74% of reported economic losses. Since there is considerable scope for improved analysis of disaster aspects, we aim to provide a more specific analysis of the dependency between these factors using relevant visualization and statistical methods.

The study by Coronese et al. presented evidence for an increase in the economic damages due to natural disasters [7]. They have analyzed event-level data using regressions to capture patterns in the economic damage distribution. This pattern is strongest in temperate regions, suggesting that the prevalence of devastating natural disasters has broadened beyond tropical regions and that adaptation measures have had some mitigating effects on damages. Geiger et al. expressed serious concerns regarding the analysis and the interpretation of the results [8]. They suggested that the capital stock metric should be used as the dependent variable instead of GDP which requires exclusive access. Their interpretation was that climate change was more attributed to the intensity of the disaster events rather than economic damages. This particular research focused only on the shortcomings of the previous study and does not provide a methodology to overcome them. Therefore, we aim to apply a correlative approach to infer the dependency between the three factors with open-source data.

Donner et al. proposed that the socio-economic diversity and demographics of a region play an important role in assessing the disaster risk and vulnerability of a region [9]. SAMHSA published

their findings on how disasters affect people of low socioeconomic status (SES) [10]. They are comparatively less prepared for disasters than others and it relates to the fact that people of low SES cannot always afford more expensive preparedness actions. Hence, we have incorporated an analysis among countries with varying sustainable development index (SDI) where lower SDI denotes countries with low standards of living.

2.3 Integration of heterogeneous datasets and data visualization

James proposed a method for the data integration of heterogeneous datasets [11]. As more analytical functions increase, the need for interacting with heterogeneous data increases. Being able to discover data from other sources, rapidly integrate that data with one's own, and perform simple analyses, often by visualizations, leads to insights that are considered important assets. Traditional enterprise approaches such as creating data warehouses with carefully analyzed data organization and regular updates and curation are used for organizing structured data. This research proposes three major steps to achieve the objective, namely data discovery, integration and exploration but does not emphasize the suitable data warehouse to be chosen for the respective use case. By taking the feasible inputs from this paper, we have adopted a cloud data warehouse called Snowflake for our data integration needs after procuring disaster datasets from multiple sources to create our own data corpus.

Snowflake has out-of-the-box features like separation of storage and computing, data sharing and third-party business intelligence tools support for advanced analytics [12]. For modelling the charts, Apache Superset is a recently developed tool that is fast, lightweight, intuitive, and loaded with options that make it easy for users of all skill sets to explore and visualize their data even at a petabyte-scale [13]. The representation of the correlation factor as a matrix uses matplotlib and seaborn libraries as they handle the combination of data frames efficiently to provide a multi-dimensional analysis [14].

2.4 Statistical analysis of related disaster factors

Weixiao et al. proposed a study describing the characteristics and losses related to natural

disasters in China between the years 1985 and 2014 [15]. The dataset was outsourced from EM-DAT but the region was confined to China and the types of disasters analyzed were predominantly floods and storms. The damages caused due to disasters focused only on life losses and economic crisis. We improvise this analysis in multiple facets by involving abundant disaster types, losses and regions and also including a correlation analysis with climate change. The visualization charts are also presented in an interactive and easily interpretable manner using current technologies.

Sandra et al. conducted research to analyze the impact of climate change on natural disasters [16]. The study also outlines the consequences of natural disasters involving a global distribution along with future projections about weather-related events. Some of the inferences drawn highlighted that though disasters are inevitable and will always be a part of nature, their frequency and intensity have been altered due to climate change, thus making regions more susceptible to multi-faceted losses.

Suryanto proposed a method for analyzing the correlation between vulnerable areas and residents' risk perception of earthquakes in a particular province called Bantul [17]. This research focused on mapping the vulnerability of the population that potentially is affected by the negative impact of earthquakes and showing the correlation between risk perception, social variables, and economic variables to the vulnerability of the region. The perception index value was calculated based on the average of the perception of the earthquake impact, the confidence level in the earthquake-resistant housing and control capabilities. Further, the correlation method was used to determine the relationship between the individual's perception of the disaster risk on the level of the vulnerability of the region and represented the same using a colour scheme. Therefore, refining this correlative model allows us to apply a similar kind of correlative analysis from a worldwide perspective for multiple disasters using a different set of factors such as economic impacts and climate change.

Thomas et al. proposed a method to observe the relationship between climate change and increase in natural disasters in the Asia and Pacific regions [18]. The growing frequency of intense natural disasters is being attributed to three key disaster risk factors: increased population exposure,

susceptibility and climate-related risks. There is a substantial relationship between the growth in natural disasters and population exposure, as indicated by population densities formulated using regression analysis. Along with the scientific link between greenhouse gases and climate change, the data in this research point to a link between rising natural disasters and human-caused greenhouse gas emissions in the atmosphere.

Michael proposed a method for analyzing the relationship between climate change, natural disasters and migration to find out any empirical evidence relating to the factors [19]. It was observed that there was a positive correlation between the frequency of occurrence of natural disasters and corresponding emigration rates of the region. The study also adds another perspective that emigration is not common in under-developed nations. The situation of migration differs widely attributing to the reason, be it a sudden occurrence of natural disaster or gradual climate change. There exists scope for applying such analysis on a broader perspective relating to economic damages caused by climate change.

Rodkin published a collection of research topics in the domain of Statistical Analysis of Natural Disasters and Related Losses [20]. They drew theoretical conclusions by applying described techniques to different natural disasters. A comparative study of losses from earthquakes, floods, tornadoes and hurricanes was presented. The losses of different types such as fatalities, number of affected people, and overall economic losses are analyzed region-wise namely in Japan and USA. The Kolmogorov test was used as the statistical tool for testing hypotheses on distribution under study. The study compares two regions with different economic strata and geographical parameters, hence the interpretations are not specialized and correlated by using socio-economic factors and historical risks of the region. However, by making use of the statistical interpretation from this publication, exploratory and relational analysis concerning multiple regions and factors are applied and results are inferred.

Go Shimada researched the impact of climate change related disasters on Africa's socio-economic factors [21]. This study uses an analytical framework to carry out the empirical analysis on

the impact of climate-related disasters on GDP per capita, agricultural production, poverty and conflict. The research inferred that climate-related natural disasters negatively impact per capita GDP growth and agricultural production. They also increase poverty in urban areas and inter-regional conflicts.

Wei et al. researched the influence of temperature anomaly on temporal and spatial variations of extreme precipitation [22]. In particular, this study aimed to infer the correlation and patterns of temperature and extreme precipitation indicators in Inner Mongolia from 1960 to 2019. Time series vector autoregression (VAR) models were adopted to obtain data characteristics over time. Spatial interpolation and trend estimators were used to analyze long-term trends of temperature which had a positive correlation with chosen precipitation metrics. However, this study is region specific and limits analysis to impacts of temperature changes on rainfall, which translates to flood impact analogy in the current proposed research.

2.5 Studied issues and proposed notion

Disaster management and environmental health is an important aspect of governance and also survival for any region in the world. A varied range of factors have to be considered prior to devising strategies for disaster preparedness and post-calamity emergency response. An adequate amount of data analysis and research provides scope for efficient resource distribution to make sure it is reaching vulnerable places and population. The proposed research paves the way for better resource and financial planning by analyzing multiple disaster related factors in real-time and presenting useful analysis for each major locality and disaster type. The study also addresses the impact of temperature anomaly on natural disasters, using statistical methods to analyze the effect of climate change on environmental factors.

Therefore, by reviewing the methodologies adopted and types of inferences made in the above studies, we have created a corpus including two unified heterogeneous datasets with necessary disaster and climate change factors. We have further explored a scope of three-dimensional analysis using charts and correlation evaluation by considering important aspects of disasters that can be

generalized across all regions.

3. Methods

This section describes the methodologies adopted to develop the heterogeneous datasets required for creating visualization charts and performing correlation analysis of disaster factors with climate change. The scheme of the system is depicted in the process diagram shown in Fig. 1.

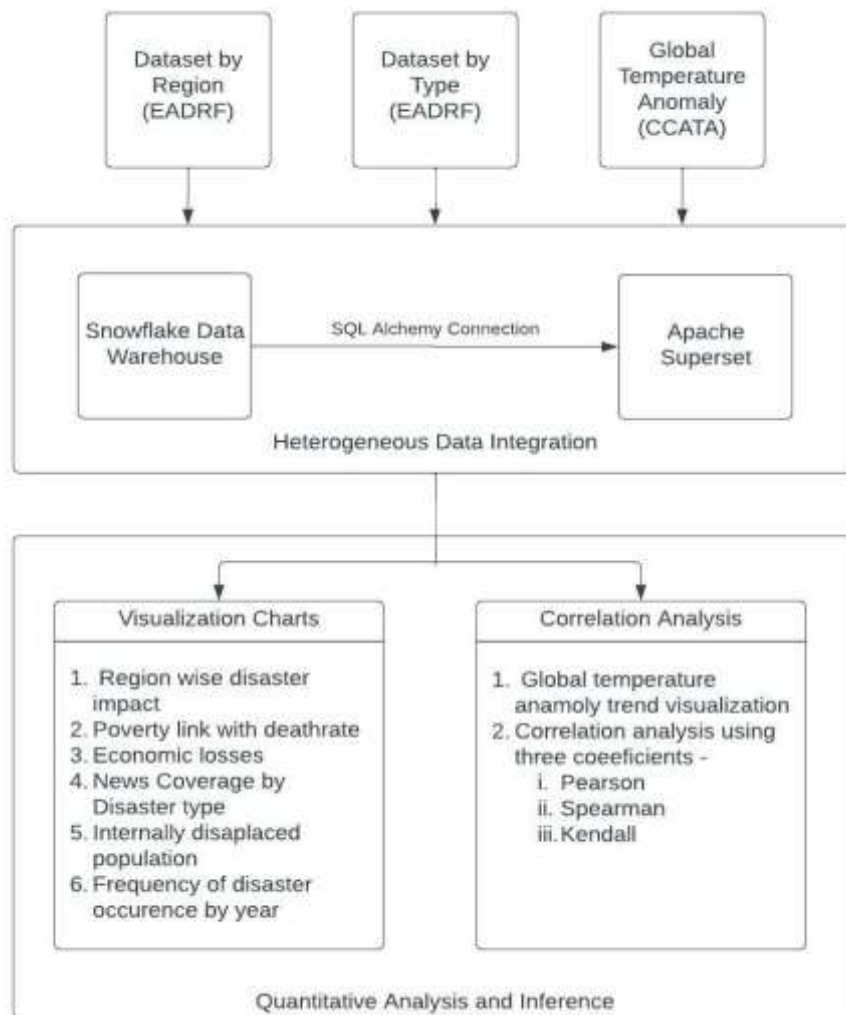

Figure 1 Process Diagram

3.1 Description of the Dataset

A wide range of factors contributes to the occurrence of disasters as well as the impact of their consequences. A collection of five datasets was outsourced, namely, frequency of occurrence of natural disasters, details of affected population due to disasters, economic damages caused by

disasters, news coverage of disasters and Earth's global temperature data.

The datasets were built into two main corpuses using Snowflake [EM-DAT (2020), Berkeley Earth (2017)]. The attribute selection from the raw data was performed by considering the usefulness of the metric, redundancy and consistency of the data. Some of the disaster-related factors are not included due to presence of a higher proportion of null values in the time frame chosen for analysis, which when considered would lead to inaccurate dependencies. The main objective of developing two heterogeneous datasets is to combine their respective analysis using common metrics while also maintaining a separate corpus for closely related factors.

The first dataset – Exploratory Analysis for Disaster-Related Factors (EADRF)- consists of the distribution of disaster data by region and type of disaster with indicators for damages represented numerically as deaths, affected, injured, homeless, loss in GDP etc. The types of disasters included in the dataset are floods, earthquakes, droughts, landslides, volcanic activity, wildfires, extreme temperature and weather. The second dataset- Climate Change Analysis using Temperature Anomaly (CCATA) includes consolidated data of global temperature anomaly for correlation analysis with disaster occurrences and economic damage.

3.2 Data Visualization

Raw historical data on disaster types and effects cannot be utilized to make interpretations. However, insightful visualization tools of the raw disaster data can provide meaningful inferences by accounting for multiple facets. Besides using some basic statistical representations such as bar graphs and pie charts, we have included some use-case specific charts such as time-series charts and area charts. For world map visualizations, corresponding ISO codes were embedded in the dataset.

A time-series chart illustrates data points at successive intervals of time. We have chosen the appropriate interval to be yearly, to represent annual trends in disaster factors. A sunburst chart is used to conveniently visualize a hierarchical dataset without filtering, through a series of concentric rings, where each ring is segmented proportionally to represent its constituent ratio or percentage. A dual-line chart is used to represent multiple measures with two different axis ranges. An area chart

'stacks' trends on top of each other to illustrate how the percentage of certain aspects of the dataset is changing over time. Therefore, when combined with a table calculation that represents the share of the total for each dimension member in the visualization, stacked area charts are an effective way to evaluate trends in distributions.

The EADRF dataset is mainly used for developing charts related to disaster factors such as the frequency of occurrence, type and region-wise losses, economic damages and crisis-related analysis and news coverage of disasters. Whereas, the visualizations consisting of temperature anomaly and correlation analysis are created using the integrated EADRF and CCATA datasets by choosing common attributes.

3.3 Correlation Analysis

Disaster-related information consists of data from multidisciplinary sources involving numerous factors in the real-time scenario. To analyze this dynamic and large quantitative data, correlation analysis is a suitable method that estimates the linear association of various disaster factors. The inferences obtained from this analysis provide scope for forecasting disaster events based on the relationship with correlated entities like climate change and temperature anomaly. The correlation model also adds a dimension of statistically proving common notions of causes and effects related to disasters.

The correlation coefficient represents the strength of the relationship between the relative dynamics of two variables as a statistical measure. The values range between -1.0 and 1.0. Correlation coefficient values less than +0.8 or greater than -0.8 are not considered significant. The most commonly used correlation coefficient is the Pearson correlation (r). This measures the strength and direction of the linear relationship between two variables, therefore there is a need for a linear relationship between the pair of variables. High linearity with a straight-line graphical representation in the relationship of variables indicates high correlation between them. Equation (1) formulates the Pearson linear correlation coefficient.

$$r = \frac{\sum_{i=1}^M (X_i - \bar{X})(Y_i - \bar{Y})}{\sqrt{\sum_{i=1}^M (X_i - \bar{X})^2 (Y_i - \bar{Y})^2}} \quad (1)$$

Spearman correlation coefficient is a statistical method of measuring the non-parametric correlation that indicates the dependency between two samples. It is applied in the cases of the lack of normally distributed nature within the variable set, therefore not requiring a linear relationship. It does not assume the distribution of data, measures variables with ranking or the size rank-order standard, and calculates the size of rank-order correlation coefficients between two variables. Spearman's method is more sensitive to error and discrepancies in the data. Equation (2) formulates the Spearman rank-order correlation coefficient.

$$r_s = 1 - \frac{6 \sum d_i^2}{N(N^2 - 1)} \quad (2)$$

The Kendall correlation coefficient measures the non-parametric correlation that indicates the dependency between two samples using information converted with data standards or ranking standards. The interpretation of Kendall's Tau coefficient in terms of probabilities of observing agreeable and non-agreeable pairs is very direct. Equation (3) formulates the Kendall rank-order correlation coefficient.

$$\tau = \frac{N_c - N_d}{\frac{1}{2}N(N-1)} \quad (3)$$

The integration of data has allowed for the creation of an efficient data corpus and ingesting it through the Snowflake data warehouse enables cloud-storage of the data. The connection with Apache Superset provides an interface to develop visualization charts and consolidate the results as a dashboard for presentation. To implement the correlation analysis module, machine learning libraries are used to observe suitable patterns in data. The appropriate correlation function is chosen for the data samples and the coefficients are tabulated which is fine-tuned for better representation as a correlation heatmap matrix.

4. Results and Performance Analysis

4.1 Experimental Setup

The implementation of this research requires a minimum of 8 GB RAM to support applications like Jupyter Notebook. Apache Superset is a visualization tool that requires an Ubuntu environment for installation. It can be easily connected with Snowflake databases and schemas using a simple connection URL that can be created using credentials of the Snowflake account. To ensure minimal consumption of cloud data warehouse credits in Snowflake, it is advised to use an extra small warehouse size, which is ideal in the long run. The hardware and software requirements are summarized in Table 1.

Table 1: Experimental Setup and Requirements

Experimental Requirements (H/W- Hardware, S/W-Software)	Description
H/W- Computational Resources	8 GB RAM to support Jupyter Notebook
S/W- Ubuntu or Linux Subsystem	To support Apache Superset installation
S/W- Apache Superset	Open-source software for data visualization
S/W- Snowflake Cloud Data Warehouse	Sign up for 60-day free trial and use minimal warehouse size, connect with Superset using SQL Alchemy connection URL.

4.2 Performance Analysis

The two main corpora developed were further used in creating the dashboard consisting of charts for various analyses [EADRF, CCATA]. The source and purpose of each dataset is summarized in Table 2.

Table 2: Dataset Sources and their Purposes with Integration details

Description of Dataset	Source	Purpose and Integration
Frequency of occurrence of natural disasters	EM-DAT	Trend comparison with temperature anomaly
Economic damage and losses	EM-DAT	Trend for correlating the year-wise impact of

		disasters on GDP
New coverage of disasters	EM-DAT	Represents the news coverage categorized by type of disaster
Effects of disasters on human lives (affected, displaced, injured, homeless etc.)	EM-DAT	Helps to categorize disaster impacts by region and the type of disaster which caused the effect.
Global Temperature Anomaly	Berkeley Earth	Helps to plot the trend of climate change with disasters

In the EADRF dataset, we have classified the disasters by type and region as shown in Fig. 2 and Fig. 3. The dataset includes information categorized across 175 countries and 8 types of disasters. This allows for a clear demarcation to formulate the disaster losses specific to each disaster and country and analyze them individually.

ENTITY	CODE	YEAR	DEATHS	DEATH_RATE	PERCENTAGE_SHARE_DEATHS	INTERNALLY_DISPLACED_POPULATION
India	IND	2008-01-01	1734.947159	0.143342031	0.019412573	6662000
India	IND	2009-01-01	1650.188873	0.134166941	0.018182388	5304000
India	IND	2010-01-01	990.4368701	0.079265138	0.010694988	1411000
India	IND	2011-01-01	824.7629692	0.064971695	0.008770145	1503000
India	IND	2012-01-01	334.1529185	0.025904882	0.003536581	9110000
India	IND	2013-01-01	6556.513259	0.500271762	0.068948811	2145000
India	IND	2014-01-01	866.6232915	0.065157421	0.009064289	3428000
India	IND	2015-01-01	1121.625116	0.063212952	0.011607983	3655000
India	IND	2016-01-01	807.587968	0.059180022	0.00821994	2400000

Figure 2 Data classified by 175 regions consisting of 7 columns and 6469 rows

ENTITY ↓	YEAR	DEATHS	AFFECTED	HOMELESS	↓ INJURED
Flood	1882-01-01	4648	36917037	372410	25292
Flood	2015-01-01	3495	27293725	165658	23218
Flood	1994-01-01	6771	122546263	7214123	22785
Flood	2004-01-01	6982	116517821	457117	15877
Flood	1965-01-01	1401	4410813	88214	15245
Flood	1989-01-01	4716	103446717	867158	11312
Flood	2010-01-01	8356	188113195	670720	10383
Flood	2016-01-01	4720	76086888	2253027	8936
Flood	2012-01-01	3544	63730563	222538	8918

Figure 3 Data classified by 8 types consisting of 6 columns and 757 rows

Some of the visualizations that constitute the dashboard built using EADRF dataset are shown as sample cases. However, there is extensive scope for creating refined visualizations filtered by either region or type for specific analytical purposes. By default, the charts represent global data unless the country is specified. The life loss incurred due to disaster is visualized in a region-wise manner. It is followed by a proportional analysis of the affected population and the extent to which economic status can play a role in disaster survival. The colour-schemed map in Fig. 4 describes the region-wise death count due to disasters. The sunburst chart in Fig. 5 represents the hierarchical proportion of deaths from the total affected population due to each type of disaster. The multi-layered time-series chart in Fig. 6 shows the trend of death rates (number of deaths per 100,000 population) of countries grouped by the SDI metric. The legend allows for a selective visualization or explicit comparison between any desired entities on the chart.

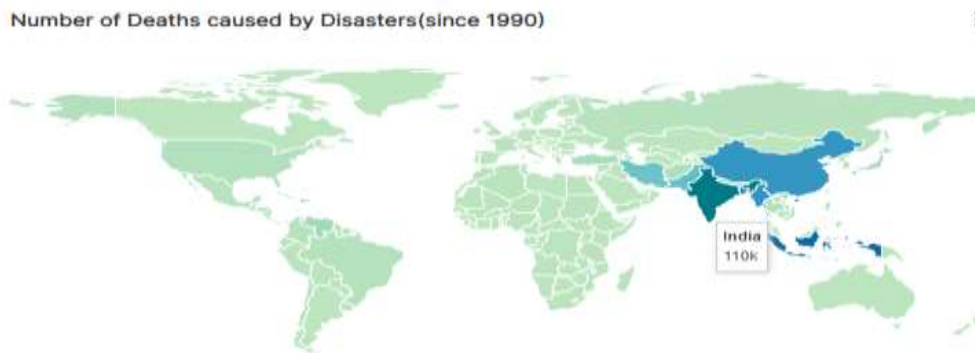

Figure 4 A colour-schemed world-map representing the number of deaths due to disasters

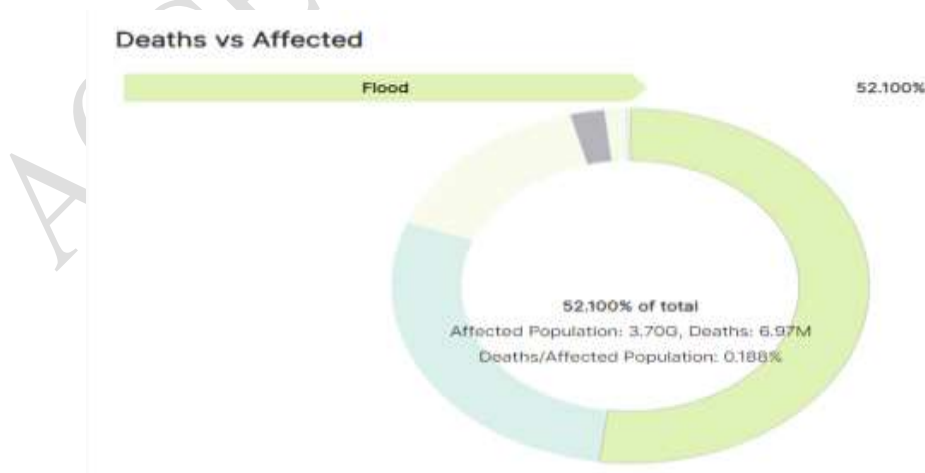

Figure 5 A sunburst chart representing the ratio of deaths to affected population for each type of disaster.

Poverty Link with Death Rate

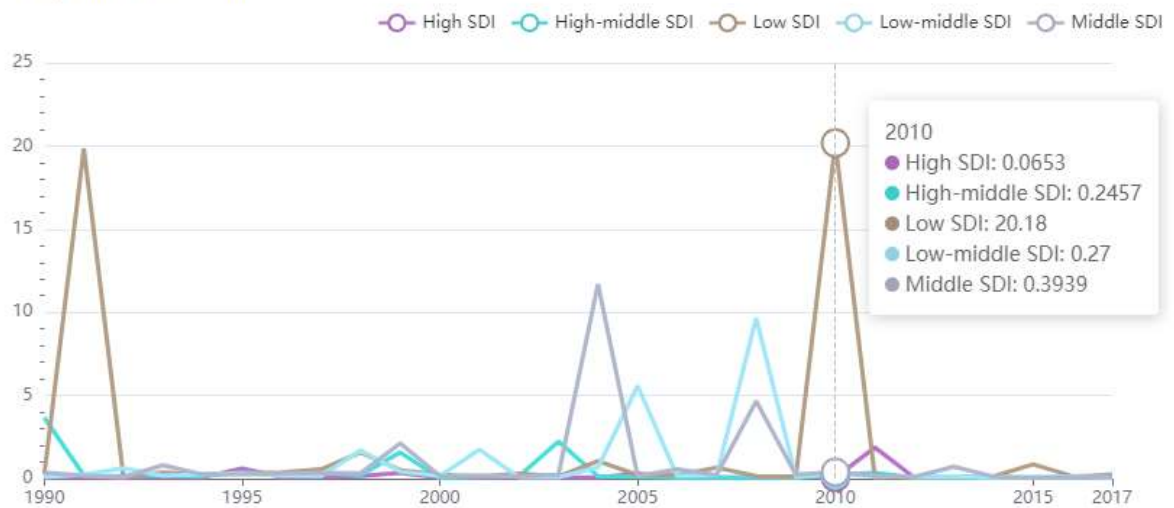

Figure 6 A time-series chart of death rates grouped by countries based on Sustainable Development Index.

Global disaster losses as a share of GDP

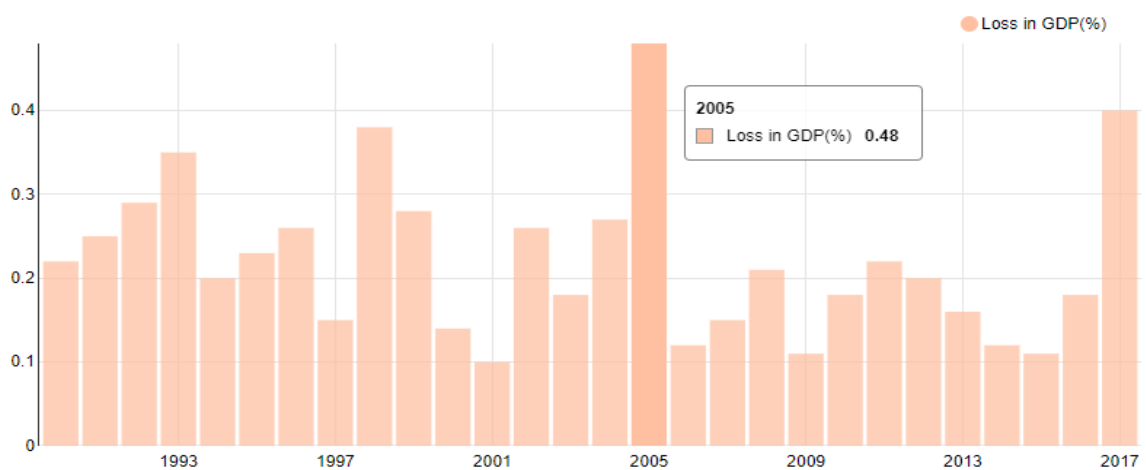

Figure 7 A bar chart of percentage loss in GDP caused by disasters

The visualization of news coverage of disaster types shows the perception people have about its influence. The bar chart in Fig. 8 shows the percentage of news coverage for each type of disaster to rank them according to newsworthiness

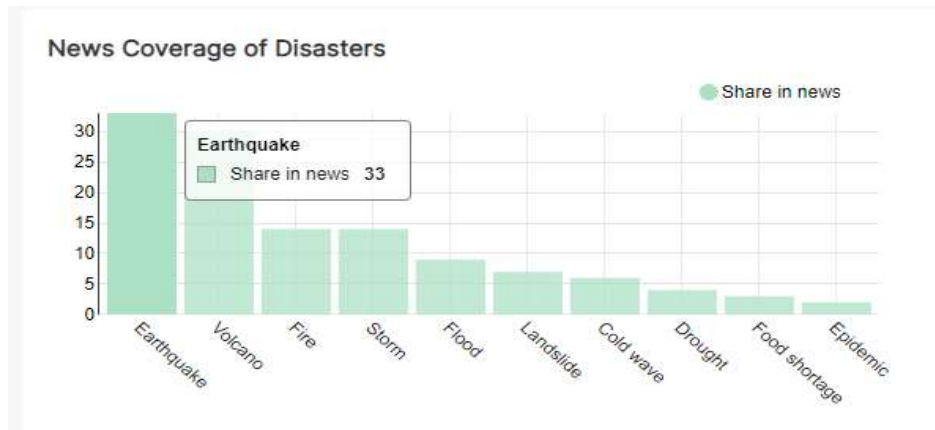

Figure 8 A bar chart of proportion of each disaster in News Coverage

Some of the common consequences of disaster occurrence are migration, homelessness and injuries. The time-series chart in Fig. 9 shows the number of internally displaced populations across the neighboring countries of India as well as the USA and UK. The area chart in Fig. 10 shows the proportion of affected, homeless and injured people due to disasters. The respective definitions are given as-

Injured: People suffering from physical injuries, trauma or an illness requiring immediate medical assistance.

Homeless: People whose house is destroyed or heavily damaged and therefore need shelter.

Affected: People requiring immediate assistance i.e., requiring basic survival needs such as food, water, shelter

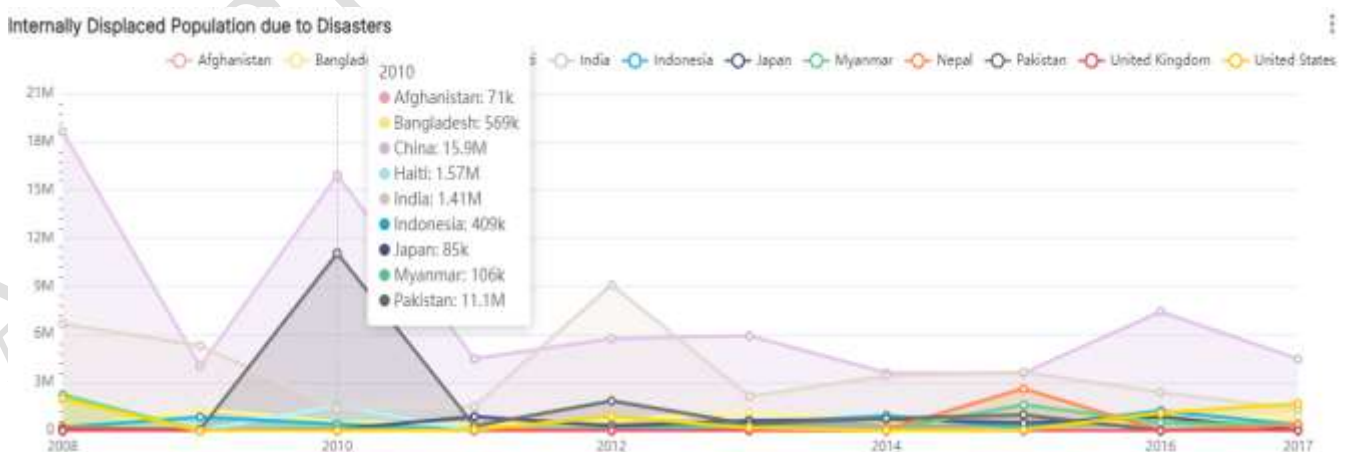

Figure 9 time-series chart of internally displaced population across neighbouring countries of India

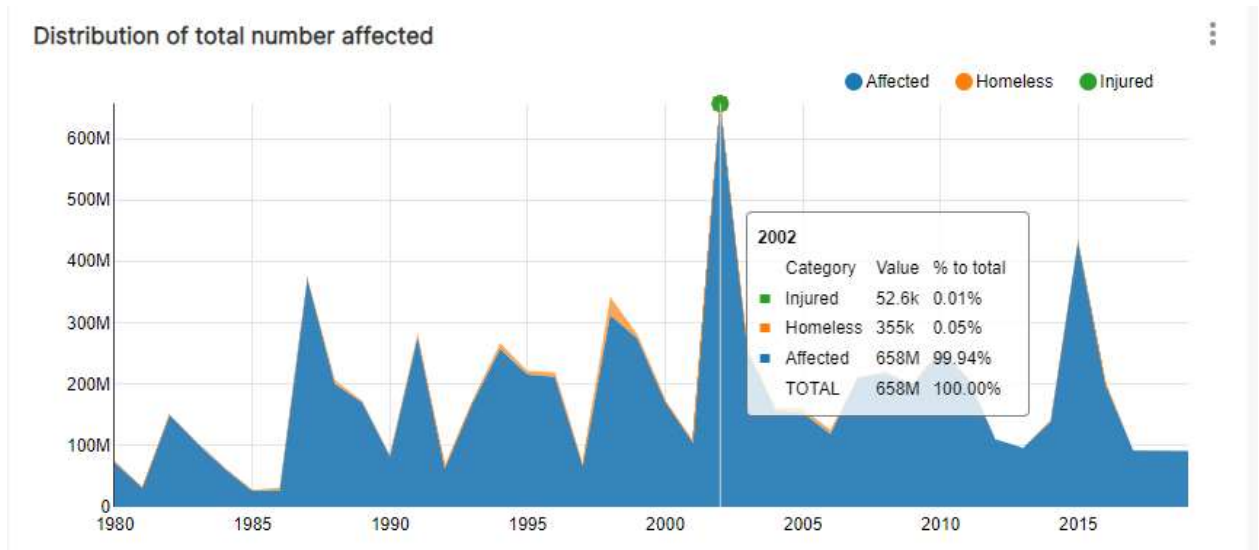

Figure 10 An area chart consisting of in-depth analysis of total affected population

Concerning the correlation analysis module, initially, we used graphical representations plotted using raw data to find suitable patterns and scope to proceed further. The area chart shown in Fig. 11 built using EADRF, stacks up each disaster entity type indicating their frequency of occurrence over the years. It is observed that the proportion of occurrence of floods has increased significantly when compared to other disasters. A general consensus of increased risk is also seen due to rise in natural calamities as time progresses.

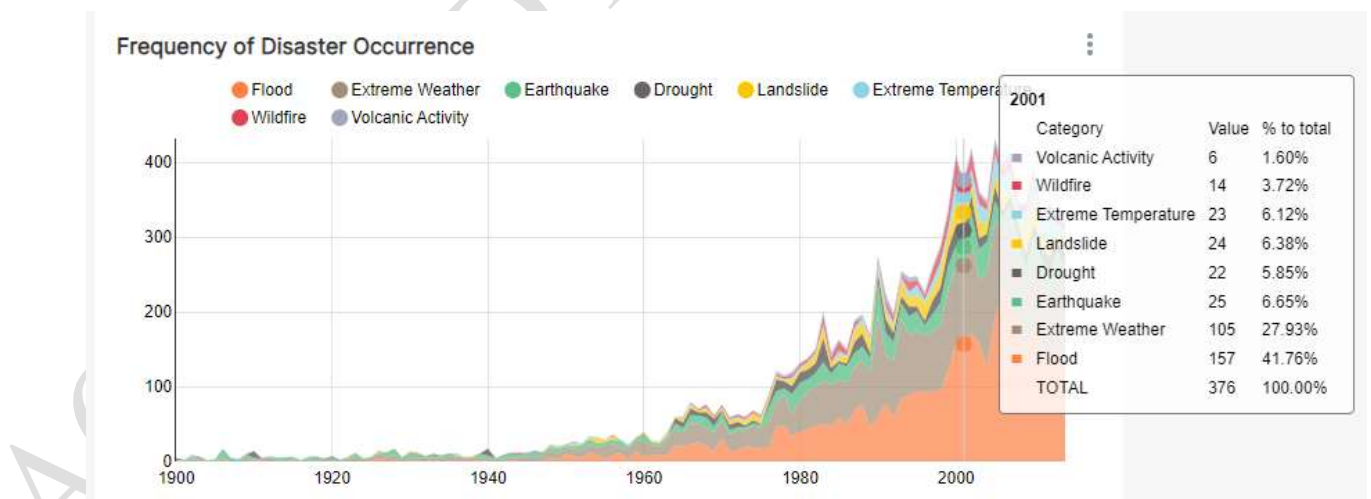

Figure 11 An area chart of global occurrences of natural disasters between 1900 and 2015

Temperature Anomaly can be defined as the amount of deviation from a certain frame of reference, in this scenario the long-term average global temperature. It is an efficient way to observe key trends in climate change because gathering absolute temperatures across the world is a difficult task. A positive anomaly value indicates that current temperature is higher than

reference level whereas a negative value indicates a cooler temperature with respect to baseline. A scientific fact that puts this into perspective is that the Earth's temperature has been rising by 0.14 Fahrenheit per decade and the warming rate since 1980 has been recorded at an alarming rate of 0.35 Fahrenheit. To estimate the feasibility of performing correlation analysis, it is necessary to plot the trend in variables to observe dependencies and their increase with time. The dual line chart shown in Fig. 12, uses data integrated from EADRF and CCATA using year as the common attribute. The trend indicates that there is a positive dependency of correlation between frequency of natural disaster occurrence and temperature deviation which is more predominant after the 1980s.

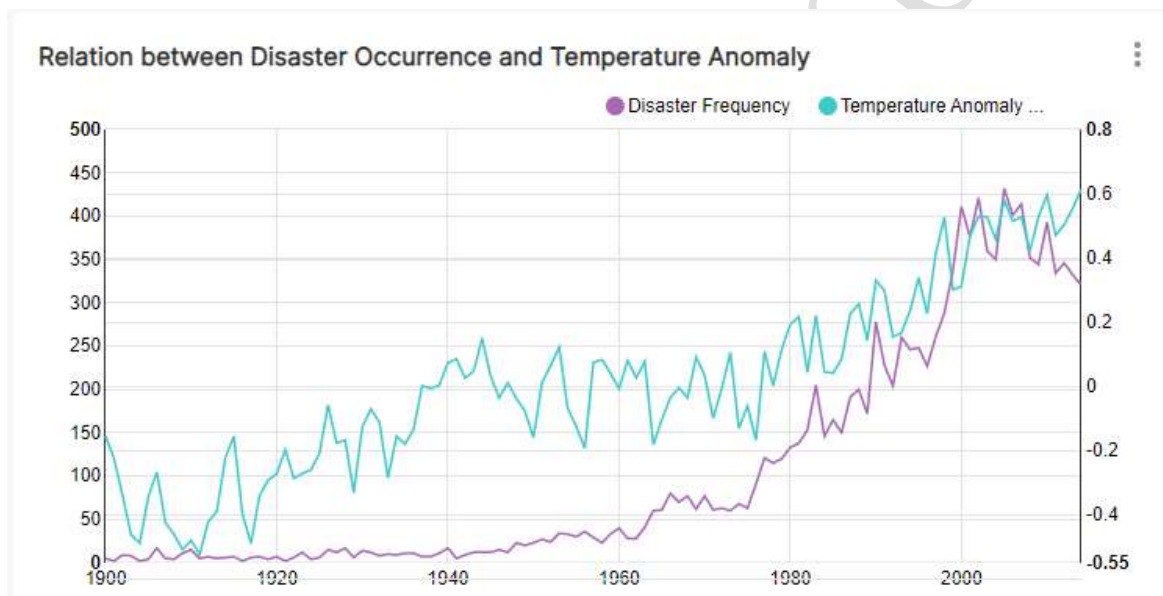

Figure 12 A dual line chart representing all natural disaster occurrences vs temperature anomaly between 1900 and 2015.

Economic damage varies greatly depending on a variety of factors such as the type of disaster, the location of the disaster, the intensity of the disaster, disaster management activities, and so on. However, one crucial tendency that emerges from the stacked area chart in Fig. 13 created using EADRF is that the total economic loss caused by all disasters has been steadily growing over time. The main factor is an increase in disaster incidence (which is linked to global warming), albeit not all disasters cause equal economic harm, for instance floods account to the most damage.

Economic Damage Caused by Disasters

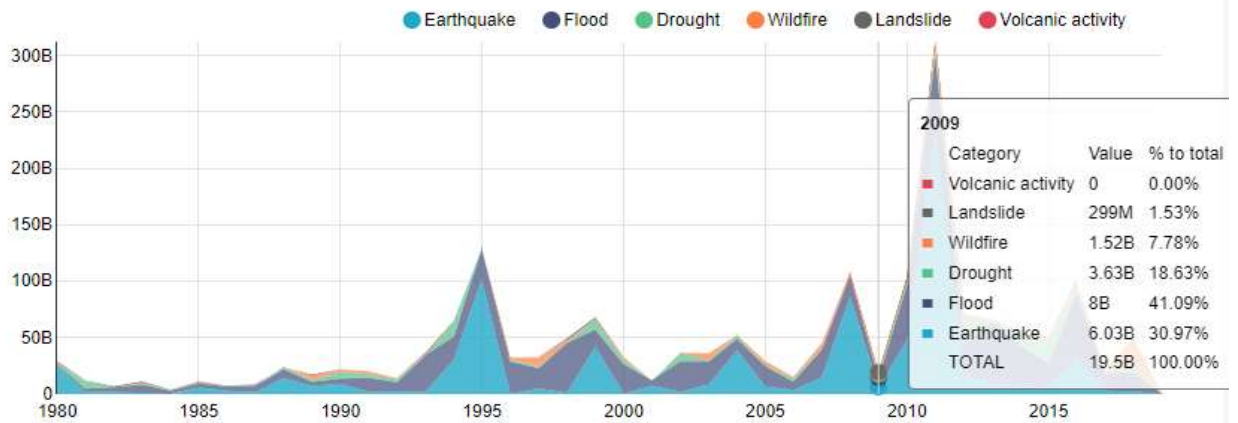

Figure 13 An area chart of distribution of each disaster in economic damages caused

By combining the two heterogeneous datasets EADRF and CCATA, a correlation table is created to enumerate the correlation between each entity. The tables shown in Fig. 14 and Fig. 15 consist of 10 rows and 10 columns, represent the Pearson correlation coefficient between temperature anomaly with disaster occurrence and economic damage respectively. Similarly, the tabulated results and matrices are obtained for Kendall and Spearman’s methodologies. The tabulated results have been limited to the head of the data frame while choosing a colour-schemed correlation matrix representation for the complete result of the analysis.

	Temperature Anomaly	All natural disasters	Drought	Earthquake	Extreme temperature	Extreme weather	Flood	Landslide	Volcanic activity	Wildfire
Temperature Anomaly	1.000000	0.865128	0.750086	0.796451	0.738191	0.848536	0.841740	0.772180	0.669120	0.683839
All natural disasters	0.865128	1.000000	0.854789	0.903392	0.859863	0.969517	0.978128	0.894296	0.788590	0.837557
Drought	0.750086	0.854789	1.000000	0.815286	0.684009	0.829133	0.785536	0.790511	0.710884	0.788781
Earthquake	0.796451	0.903392	0.815286	1.000000	0.721105	0.917687	0.824128	0.778272	0.708440	0.778318
Extreme temperature	0.738191	0.859863	0.684009	0.721105	1.000000	0.776985	0.870008	0.751340	0.556775	0.694524

Figure 14 Pearson correlation table between temperature anomaly and disaster occurrence

	Temperature Anomaly	All natural disasters	Drought	Earthquake	Extreme temperature	Extreme weather	Flood	Landslide	Volcanic activity	Wildfire
Temperature Anomaly	1.000000	0.647406	0.515849	0.346882	0.294110	0.588786	0.678628	0.353444	0.215112	0.557517
All natural disasters	0.647406	1.000000	0.498355	0.823475	0.373682	0.791300	0.832297	0.244076	0.103445	0.504414
Drought	0.515849	0.498355	1.000000	0.270173	0.026217	0.415827	0.466098	0.126578	0.247509	0.242899
Earthquake	0.346882	0.823475	0.270173	1.000000	0.291325	0.364361	0.624735	0.083710	0.087658	0.261585
Extreme temperature	0.294110	0.373682	0.026217	0.291325	1.000000	0.273596	0.251023	0.061126	0.022204	0.352994

Figure 15 Pearson correlation table between temperature anomaly and economic damages

Pearson correlation heatmaps for visualizing the dependency of temperature anomaly with disaster occurrence and economic damage are shown in Fig. 16 and Fig. 17 respectively. The heatmap obtained supports our initial assumption that disasters are indeed a consequence of climate change as indicated by the strong positive correlation coefficient value. Since economic damages constitute broader real-world issues rather than being confined to climate change, they exhibit relatively lower correlation with temperature anomaly.

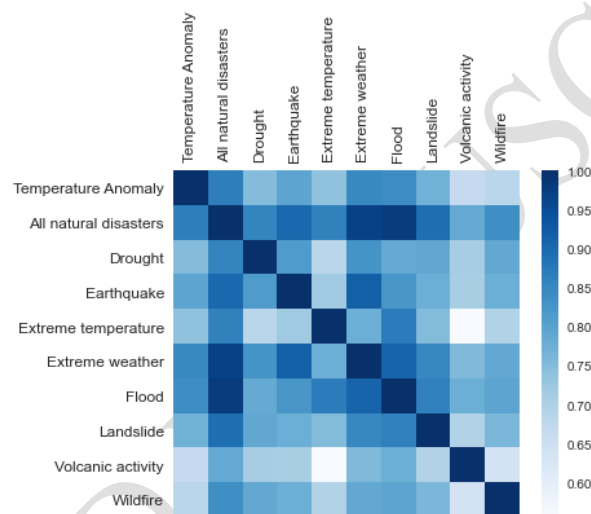

Figure 16 Pearson Correlation Heatmap for dependencies between disaster occurrence and temperature anomaly.

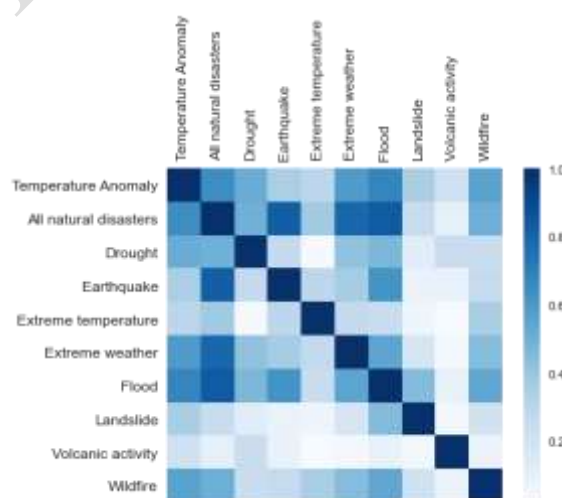

Figure 17 Pearson Correlation Heatmap for dependencies between economic damages and temperature anomaly.

Kendall correlation values and heatmap showcase a different perspective, with a slightly lower positive correlation between the occurrences of disasters and temperature anomaly while maintaining a mixed (both positive and negative) correlation coefficient with respect to economic damages. Spearman correlation values and heatmap represent a stronger positive correlation than Pearson with major disaster types such as floods and earthquakes. Concerning economic damage, the correlation is more positive compared to other coefficients.

The custom-built dataset incorporating the analysis factors allowed for the creation of a visualization dashboard with interpretable charts, to provide valuable insights required for disaster planning. Initially, we had depicted basic graphs such as year-wise global distribution of deaths and country-wise share of losses. For a further distinguishing view, various types of disasters were included, majorly earthquakes, floods, droughts, volcanoes, landslides and wildfires. The damages caused by each disaster were assessed to rank them according to their impact. This resulted in the scope for performing regional analyses and grouping them according to socio-economic metrics. To shed some light on calamities causing gradual but immense repercussions such as food shortage, we emphasized making a comparative study of news coverage among various disaster types.

A quantitative analysis made using the charts assisted us to infer region and type-specific results for a better insight. Since 1900, Haiti has been the country with the highest death toll of 2,27,000 due to disasters mostly attributed to the intense Earthquakes followed by Indonesia with 1,85,000 deaths. There occurred 10,271 disasters worldwide between the years 1970 and 2010, with 23.7% and 16.9% of them occurring in America and Caribbean countries respectively and Asia being the worst-affected continent, accounting for roughly 40% of the total. Around 9 million people were domestically displaced in India in 2012 as a result of Himalayan flash floods, whereas the count stood at 19 million in China in 2008 as a result of the Great Sichuan earthquake. The Caribbean is the region where disaster damage has accounted for the highest percentage of GDP loss on average, topping 8% seven times. Central America comes in second, with disaster damage

exceeding 8% of GDP twice.

While each disaster can be ranked through impact, it is observed that floods are the most common natural disaster by far, accounting for 43% of all recorded events. Predominantly, earthquakes, floods and droughts have resulted in a large number of deaths. Over the last few decades, high death tolls tend to result from large earthquake events, two such years being 2004 and 2010 where earthquakes accounted for 93% and 69% of total deaths respectively. Food shortages are responsible for most deaths and afflict higher number of casualties per incident occurred, but they commence in an inconspicuous manner as opposed to a sudden volcanic explosion or earthquake. As a result, food shortages are covered by news media only 3% of the time while a comparatively indulgent 30% of earthquakes and volcanic events get their time in the spotlight. To analyze the impact of each type of disaster and map them with a particular region, for instance, India, further quantitative analysis is performed and the results are interpreted. Subsequently, performing an exploratory data analysis on global temperature and disaster data indicated the suitability of the correlation approach from the available statistical methods. We studied the significance of each correlation coefficient and the varied results they produced with the dataset given. The interpretations made from correlation analysis reflected that climate change indeed enhances the disaster risk and occurrence, as well as economic losses, post the disaster.

5. Discussion

The research initially focuses on gathering organized data that supplements the analysis of various disaster factors under study. The disaster data corpus was created and integrated with global temperatures and economic losses to develop a dashboard of visualizations and perform correlation analysis. This is further supported by a thorough statistical correlation analysis and represent to arrive at useful conclusions about the initial interpretations regarding disasters and climate change. The data corpora created enabled the following quantitative analysis which was made possible using data warehousing and analysis techniques. It is followed by statistical inferences formulated using the corresponding correlation coefficients and the real-world

interpretation related to climate change and disasters occurrence.

We inferred that disasters affect those in poverty the most, high death tolls tend to be centered in low-to-middle income countries without the infrastructure to protect and respond to events. There is notable year-to-year variability in costs ranging from 0.15% to 0.5% of global GDP. In recent decades there has been no clear trend in damages when we take into account economic growth over this period. In India, the economic damages due to floods are the costliest, causing 63% of the total, followed by cyclones (19%), earthquakes (10%) and droughts (5%). In terms of human casualties, the earthquake is the most lethal disaster in India with 33% of casualties, followed by floods with 32%. The type of disaster matters to how newsworthy people find it to be. The news attention does not reflect the severity and number of people killed or affected by a natural disaster. Food shortages, for example, result in the most casualties and affect the most people per incident but their onset is more gradual than that of a volcanic explosion or sudden earthquake. Hence, nearly 40 thousand deaths due to food shortage have to be reported to receive the same newsworthiness as opposed to 2 deaths due to an earthquake.

Correlation analysis by medium variables was conducted using Pearson, Kendall, and Spearman statistical methods. Each medium variable and correlation was analyzed to be significant. Strong positive correlations were shown between the frequency of natural disasters and global warming and associated climate change scenarios, as environmentalists have been warning us. In terms of inferring the effect of disasters on the country's economy, a positive correlation was exhibited by Pearson and Spearman coefficients, while Kendall exhibited positive values for common and severely damaging types of disasters and varied values were observed for rare events. Therefore, developing countries are particularly vulnerable to catastrophes triggered by climate change and they need substantial economic support in the domain of disaster relief.

6. Conclusion

The research aimed to explore dependencies between various disaster-related factors and use the interpretations for better awareness of natural calamities and resource planning during

emergency response. The contributions of the research are outlined in the dashboard of data visualization charts that present an optimal and understandable three-dimensional view of the related disaster factors under study.

A considerable number of insightful inferences have been drawn regarding each disaster type and region, also including socio-economic factors. The positive correlation showcased between frequency of disaster occurrence and temperature anomaly highlights the impact of climate change on natural calamities from a statistical standpoint. The inferences from the research were sequentially outlined in a concise and easily interpretable manner, mainly through pictorial charts and matrices.

The future scope of the study includes the formulation of a disaster risk index by combining relevant factors from satellite imagery and social media data specific to each region to identify vulnerable regions using data patterns. Therefore, we can imply that the meaningful analysis of various types of disaster data pre and post of occurrence lays the foundation for disaster relief.

References

Emergency Events Database, WHO. (2020). Essential core data on the occurrence and effects of disasters. <https://www.emdat.be> (Date of Access: Dec 10, 2021).

Climate Change: Earth Surface Temperature Data, Lawrence Berkeley National Laboratory. (2017). Global temperatures (celcius). <https://www.kaggle.com/berkeleyearth/climate-change-earth-surface-temperature-data> (Date of Access: Nov 20, 2021).

United Nations Economic Commission for Europe. (2020). Recommendations on the role of official statistics in measuring hazardous events and disasters. <https://reliefweb.int/report/world/recommendations-role-official-statistics-measuring-hazardous-events-and-disasters> (Date of Access: Dec 1, 2020).

Lizarralde, G., Bornstein, L., Robertson, M., Gould, K., Herazo, B., Petter, A. M., Páez, H., Díaz, J.H., Olivera, A., González, G. and López, O. (2021). Does climate change cause

disasters? How citizens, academics, and leaders explain climate-related risk and disasters in Latin America and the Caribbean. *International Journal of Disaster Risk Reduction*, 58, 102173-102176.

UN Office for Disaster Risk Reduction. (2020). The human cost of disasters: An overview of the last 20 years (2000–2019).

World Meteorological Organization (WMO). (2021). Weather-related disasters increase over past 50 years, causing more damage but fewer deaths. <https://public.wmo.int/en/media/press-release/weather-related-disasters-increase-over-past-50-years-causing-more-damage-fewer> (Date of Access: Dec 2, 2020).

Coronese, M., Lamperti, F., Keller, K., Chiaromonte, F. and Roventini, A. (2019). Evidence for sharp increase in the economic damages of extreme natural disasters. *Proceedings of the National Academy of Sciences*, 116(43), 21450-21455.

Geiger, T. and Stomper, A. (2020). Rising economic damages of natural disasters: Trends in event intensity or capital? *Proceedings of the National Academy of Sciences*, 117(12), 6312-6313.

Donner, W. and Rodriguez, H. (2011). Disaster risk and vulnerability: The role and impact of population and society. *Population Reference Bureau*. Resource Library. Washington, D.C.

Disaster Technical Assistance Center Supplemental Research Bulletin, Substance Abuse and Mental Health Services Administration (2017). Greater impact: How disasters affect people of low socioeconomic status. https://www.samhsa.gov/sites/default/files/dtac/srb-low-ses_2.pdf (Date of Access: Nov 18, 2020).

Hendler, J. (2014). Data integration for heterogeneous datasets. *Big data*, 2(4), 205-215.

Dageville, B., Cruanes, T., Zukowski, M., Antonov, V., Avanes, A., Bock, JJ., Claybaugh, J., Engovatov, D., Hentschel, M., Huang, J. and Lee, A.W. (2016, June). The snowflake elastic data warehouse. In *Proceedings of the 2016 International Conference on Management of Data*, 215-226.

- Michele, P., Fallucchi, F. and Luca, E. W. D. (2019, October). Create dashboards and data story with the data & analytics frameworks. In *Research Conference on Metadata and Semantics Research*, 272-283. Springer, Cham.
- Bisong, E. (2019). Matplotlib and seaborn. In *Building Machine Learning and Deep Learning Models on Google Cloud Platform*, 151-165. Apress, Berkeley, CA.
- Han, W., Liang, C., Jiang, B., Ma, W. and Zhang, Y. (2016). Major natural disasters in China, 1985–2014: occurrence and damages. *International Journal of Environmental Research and Public Health*, 13(11), 1118.
- Banholzer, S., Kossin, J. and Donner, S. (2014). The impact of climate change on natural disasters. In *Reducing disaster: Early warning systems for climate change*, 21-49. Springer, Dordrecht.
- Sartohadi, J., Suryanto, S. and Kuncoro, M. (2012). Physical characteristics and disaster risk perception correlation at Bantul regency. *Economic Journal of Emerging Markets*, 4(1), 76-86.
- Thomas, V., Albert, J. R. G. and Hepburn, C. (2014). Contributors to the frequency of intense climate disasters in Asia-Pacific countries. *Climatic Change*, 126(3), 381-398.
- Berlemann, M. and Steinhardt, M. F. (2017). Climate change, natural disasters, and migration—a survey of the empirical evidence. *CESifo Economic Studies*, 63(4), 353-385.
- Pisarenko, V. F. and Rodkin, M. V. (2014). Statistical analysis of natural disasters and related losses, 82. *Dordrecht-Heidelberg-London-New York: Springer*.
- Shimada, G. (2022). The impact of climate-change-related disasters on Africa's economic growth, agriculture, and conflicts: Can humanitarian aid and food assistance offset the damage? *International Journal of Environmental Research and Public Health*, 19(1), 467.
- Zhu, W., Wang, S., Luo, P., Zha, X., Cao, Z., Lyu, J. et. al. (2022). A quantitative analysis of the influence of temperature change on the extreme precipitation. *Atmosphere*, 13(4), 612.